



Application Handbook

Understanding
and Specifying

Sight Glass Lighting

TABLE OF CONTENTS

Introduction	1
Light Technologies	1
Light Output	3
Determining Wattage for Your Application	8
Mounting Lights	9
Light Accessories	11
Environmental Considerations	11

L.J. Star Incorporated provides an extensive line of process observation equipment—sight glasses, lights, sanitary fittings, and level gage indication. Product lines include Metaglas® Safety Sight Windows, Lumiglas® Explosion Proof Lights and Cameras, Visual Flow Indicators, Sight Ports, Sanitary Clamps, Magnetic Level Gages and Gage Glass. Metaglas is the #1 selling fused sight glass, proven in thousands of installations around the world. Unlike some other sight glasses, it meets stringent DIN 7079 and DIN 7080 quality standards, and has been tested and proven to meet the USP Type I standard.

INTRODUCTION

How to Spec Lighting for Sight Glass Applications

Chances are the interior of vessels and pipelines are too dark for operators to view important stages of their process through a sight glass. Flashlights cannot supply sufficient lighting, and may cause a glare on the sight glass, making visual inspection virtually impossible. Therefore, illumination must be supplied by mounting lights (also called “luminaires”) onto sight glasses.

When deciding upon a proper light for an application, be sure to consider all of the properties of the light. The type of technology, size, weight, voltage, wattage, materials of construction, mounting configuration, and light pattern are all very important factors. So are energy consumption, location requirements (i.e. hazardous), heat output, ambient conditions, and vibration. This handbook covers all these considerations so that specifiers can choose the ideal lighting solution for the application.

LIGHT TECHNOLOGIES

There are several technologies used to generate light. The types of lights include incandescent, halogen, LED, metal halide (HID), compact fluorescent (CFL), and fiber optic. Halogen lights are the most common types used in sight glass applications, but LED lights are growing in popularity.

Halogen and Incandescent Lights

- 85% of energy is consumed by heat generation – not energy efficient
- 2800 K temperature approximates dusk and causes eye fatigue
- Emit a spherical light source that is difficult to capture and apply to the operational field
- Filament can be damaged by shock, vibration and over-voltage, shortening bulb life
- Limited bulb life rating requires routine maintenance for bulb replacement
- Inexpensive and readily available

LED Lights

- Long service life (five years and improving) reduces need for maintenance
- Shock and vibration resistant because there is no filament
- Smaller size compared to halogen and incandescent lights of same brightness
- Cold light output
- Energy efficient (low operating costs – green technology)
- Generate directional light
- Easy-to-control color output for greater definition and less eye fatigue
- Can remove potentially harmful or unwanted radiation, such as ultraviolet and infra-red light

Metal Halide (HID) Lights

- Cool burning
- Consume less power than halogen lights
- Produce more light at higher color temperature
- Require a ballast
- Often the best choice where long continuous use and high intensity output are required

Compact Fluorescent Lights (CFL)

- Require proper disposal (mercury)
- Last around 10,000 hours
- 20–25% of energy cost compared to halogen
- Difficult to reflect; not good for process vessel lighting
- Most commonly used for residential area lighting

Fiber Optic Lights

- A specially designed halogen bulb generates the light into a bundle of fiber optic strands which transmits the light to the sight glass
- The light housing can be mounted several feet away from vibrating equipment to preserve bulb life
- LED technology can also be used as the light source
- Can easily be designed for cold light output

Comparison of LED and Halogen/Incandescent Lighting

	LED LIGHT	HALOGEN AND INCANDESCENT LIGHTS
Heat Generation	5% of energy consumed is lost to heat generation	85% of energy consumed is lost to heat generation
Efficiency	55.6 lumens per watt	10 lumens per watt
Color Temperature	4800 - 6300 K temperature, approximates daylight, provides greater ground definition and less eye fatigue	2800 K temperature approximates dusk and causes eye fatigue
Usable Pattern	Emits a directional light source that can efficiently be captured and translated into the operational field	Emits a spherical light source that is very difficult to capture to the operational field
Life	Filament free design	Filament design that when subjected to shock and vibration causes damage and shortens bulb life (instant expiration)
Value	Lower maintenance costs, better warranty coverage, lower power consumption, and longer life	Routine maintenance, standard warranty, high power consumption, and shorter life

LIGHT OUTPUT

Terms of Light Measurement: Lumens and Foot-Candles

Lumens is a measurement of light in all directions. This unit of measurement is best used for incandescent bulbs. When a reflector is used, the light is reflected in one direction. As a result, lumens is not an effective measurement of reflective light. Therefore, the unit of measurement that measures light at a distance from the bulb is called candela, which is more commonly referred to as foot-candles.

Another effective unit of measurement of reflective light is called lux. Foot-candles can be converted to lux by the following formula:

$$\text{Foot-Candles} \div 0.0929 = \text{Lux}$$

Generally speaking, foot-candles and lux are inversely proportional to the distance squared. For example, a lux of 200 at a distance of 5 feet from a bulb

is 50 lux at a distance of 10 feet. In other words, if the distance is doubled then the lux is reduced to $\frac{1}{4}$ of the original lux.

Relationship of Voltage to Light Output

A bulb with lower voltage (say 24V) will produce light more efficiently than a bulb with higher voltage, such as 120V. Here is the basic power formula:

$$\text{Voltage} \times \text{Amperage} = \text{Wattage}$$

As the voltage increases and the wattage remains the same, the amperage must be reduced. In other words, the amperage is inversely proportional to the voltage, assuming the wattage remains constant. As a result, the higher the voltage the more resistance is needed. Therefore, a longer, thinner filament is required.

A shorter, thicker filament has two benefits: First, a thicker filament can burn hotter and produces a brighter, whiter light. Second, a shorter filament produces more light at the reflector's focal point, resulting in more efficient reflections.

Reflector

In order to maximize the light output using a reflector, the center of the bulb's filament must be placed at the focal point of the reflector. The intention is to have all the light directed in a parallel manner (see Figure A). There will always be some angle of light since some light will be direct (see Figure B). A typical angle of reflection for a spot configuration is 10°. The shape of the reflector and its position in relationship to the bulb affects how wide or narrow the beam will be.

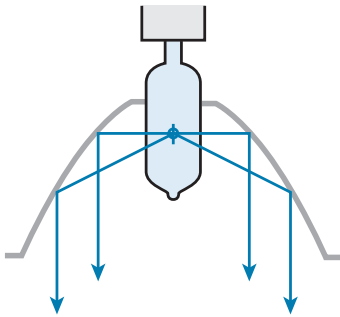

Figure A

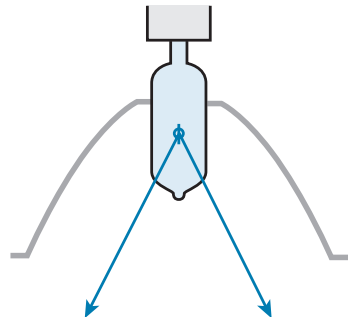

Figure B

Flood Light

It is not always desirable to have a narrow light beam or a spot light. There are three ways to accomplish this, but keep in mind that light efficiency will be compromised. The first way is to position the center of the filament near the ends of the reflector (see Figure C). In addition, this allows for more direct light to be generated.

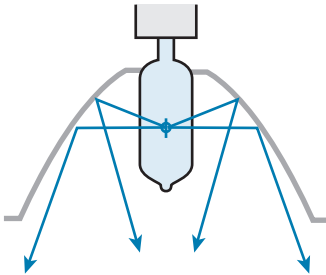

Figure C

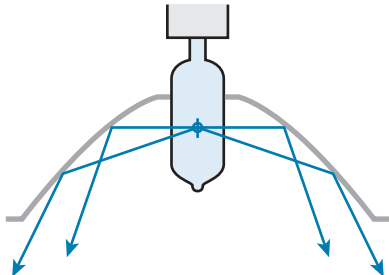

Figure D

A second method is to design the reflector at a slightly different parabolic shape so as to reflect the light at angles (see Figure D). A third way can be accomplished by a dimpled glass lens which is usually incorporated into the bulb and reflector, known as an encapsulated bulb. A common example of this is an outdoor floodlight. A typical angle of reflection for a floodlight is approximately 30–35°.

Light Intensity (Output)

The light required for a given task depends on the nature of the task. The table below shows that tasks for close inspection require more light than other tasks. Unfortunately, this table is not as helpful for specifying lighting for process observation. For this, the specifier must trust experience or seek the advice of a lighting supplier.

TYPICAL TASKS	LIGHTING REQUIREMENTS	SUGGESTED FOOT-CANDLES
Difficult tasks, reading, general office work, inspection, complex assembly, color coding, adding finishes to products, repair involving small parts	Bright	100-200
Moderate assembly, sorting, checking, complex bench work, viewing instrument panels, automotive repair, office hallways	Moderate	50-100
Casual tasks, simple assembly, grinding, simple inspection, packing, labeling, general industrial work	General	20-50
Washrooms, rough active storage, mechanical rooms	Adequate	10-20
Inactive storage, stairs	Dim	5-10

When determining how much illumination is needed for a particular viewing task, the factors to consider are the depth of the vessel, its characteristics, the required viewing area, and the nature of the material under view. What is the view distance, and does it change significantly if the vessel must be observed at both full and empty levels. If the vessel interior is polished and offers a reflection, then lower wattage light may be used compared to a glass-lined vessel with a dark surface that absorbs light. Is a wide view of the process essential, or will a narrow view suffice? A larger view will require higher light output. Finally, the material under view plays a role. Light colors need less light; dark colors need more. If the goal is simply to observe level, then this task may be accomplished with little light. If the goal is to observe residue, then more light may be needed. If the goal is to inspect for the presence of foam, then a wide view may be needed that may require more light.

Light Distribution Chart

The following is a typical light chart that illustrates the intensity of light at various distances from the bulb. In addition, the chart shows the diameter of the area illuminated at the various distances. The design of the reflector to the bulb will determine the distribution pattern, or angle of light.

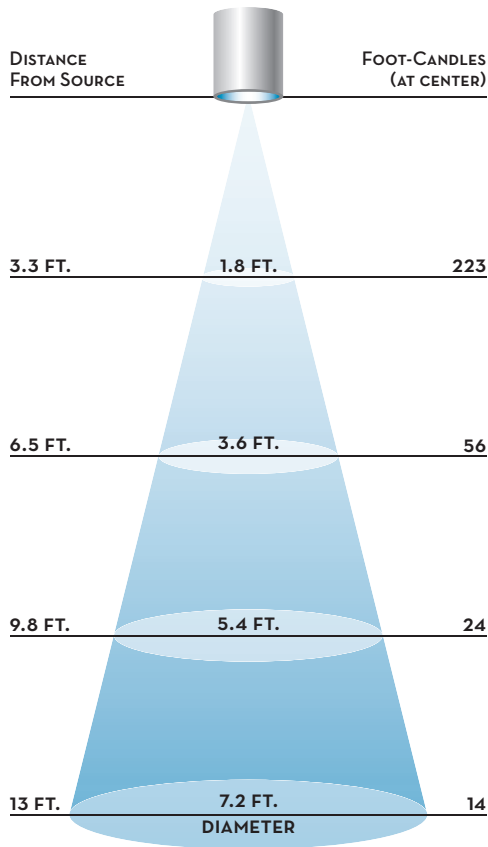

Reducing Heat Output

A typical halogen bulb produces 15% light and 85% heat. Heat comes from the infrared light of a bulb, which cannot be seen by the naked eye. There are three ways to reduce the IR light (or heat) from a light source. First is the use of a cool beam bulb. This type of bulb incorporates a reflector that allows IR light to pass through while reflecting only the white or visible light. However, this is not 100% efficient in eliminating IR light from exiting the luminaire since some light is direct and does not pass through the reflector.

A second method of reducing IR light from a halogen bulb is to incorporate an IR mirror. This device, placed opposite the reflector, reflects the IR light

back into the luminaire while allowing the visible light to pass through. A third solution, similar to the IR mirror, is an IR filter. However, instead of reflecting the IR light, the filter absorbs it while allowing the visible light to pass through. An IR filter is often used in the pharmaceutical and biotech applications when the product under process is heat sensitive. The combination of a cool beam bulb and an IR mirror or filter is very efficient.

It should be noted that LED lights are available that do not add heat to the process. These lights have the additional advantage of extremely long life and are shock and vibration resistant, which reduces maintenance costs. In addition, metal halide, or high intensity discharge (HID), lights produce much less heat since they operate at much lower wattage compared to halogen lamps of equal intensity.

Filtering Light Output

Filter glass is available that will block light of a certain color. The filter may be added in lighting applications in which the process fluid is light sensitive, such as a photo process fluid. A light of higher intensity may be needed to provide sufficient illumination for viewing.

DETERMINING WATTAGE FOR YOUR APPLICATION

The wattage of the bulb you select should be based on the distance of the bulb from the target. The following figure shows the maximum recommended distance for bulbs of different wattages. This chart is for halogen bulbs only. For LED and metal halide (HID) lights, convert the wattages to the halogen equivalent, and then apply to the following figure. Most manufacturers of these special lights will provide the halogen equivalent.

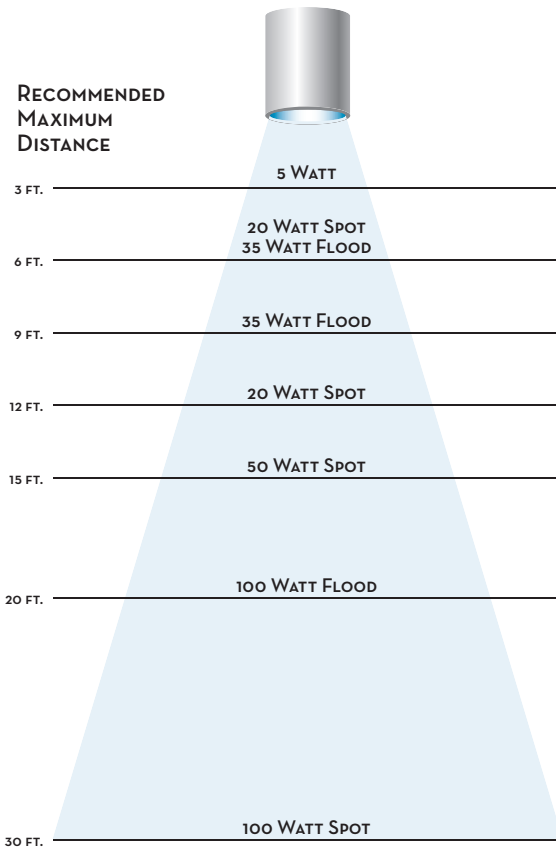

MOUNTING LIGHTS

Lights use different mounting configurations ranging from a “half-moon” type that fits a weld-on sight port to a light that fits directly into a sanitary fitting for one-piece mounting onto a sanitary ferrule. To add lights to existing sight glasses, mounting brackets are often an option to mount directly to the retaining flange. Brackets are also the most common means of mounting lights on sight flow indicators.

In some applications, one sight glass is used for viewing and another is dedicated to lighting. In this case, a light may be equipped with a built-in sight glass or it is often mounted onto a sight glass the same diameter of the

**SIGHT GLASS LIGHTING
APPLICATIONS HANDBOOK**

light. Other designs have the light mounted off-center of a larger sight glass, allowing combined lighting and viewing.

If a sight glass is too small to utilize a standard light and leave room for viewing, then a fiber optic light is recommended. The fiber optic bundle mounts to the sight glass and the halogen bulb or other light source may be mounted at a distance. This arrangement is good for tight spaces and for moving the light source away from vibration that could damage the bulb filament and reduce bulb life.

Often, standard mounting options will not fit to the design of an existing port. Special ports may require special mounting. Special mounting configurations can be designed to suit specific requirements. Below are some mounting configurations.

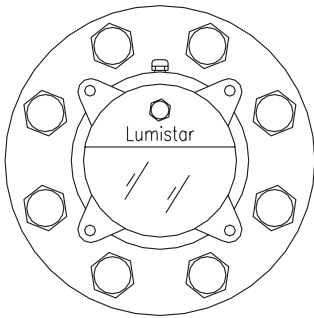

**HALF-MOON LIGHT &
SIGHT PORT COMBINATION**

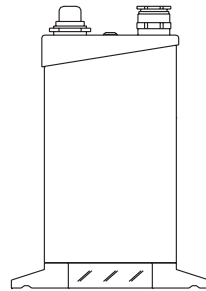

**SANITARY CONNECTION
LIGHT PORT ONLY**

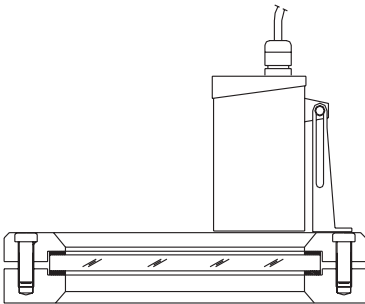

**BRACKET MOUNT LIGHT &
SIGHT PORT COMBINATION**

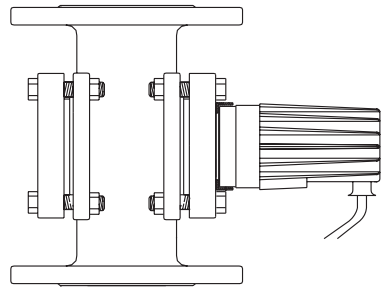

**LIGHT MOUNTED ONTO
VISUAL FLOW INDICATOR**

LIGHT ACCESSORIES

Special consideration should be given to determine how the light will be controlled. A simple solution is a pushbutton switch that the operator can press when he or she needs to see inside the vessel. Alternatively, the light may be controlled by an electronic or pneumatic timer that, when manually activated, keeps the light on for a pre-determined length of time. Video cameras are also available that include lighting in their configuration. Of course, if the application is in a hazardous location, then these accessories must satisfy requirements for explosion-proof rated devices.

ENVIRONMENTAL CONSIDERATIONS

Explosion Proof Ratings

Many processes take place in hazardous environments where explosive conditions may be present. Explosion-proof lights, often called EX lights, are readily available for these applications. The datasheet of the specific light will state which standards the light meets.

The standards for hazardous locations are defined by the National Electric Code (NEC) Article 500. For Class I ratings, the level of hazard depends on frequency of occurrence. The longer the material is present, the greater the risk.

FREQUENCY	DIVISION SYSTEM	ZONE SYSTEM
Continuous	Class 1, Division 1	Zone 0
Intermittent Periodically		Zone 1
Abnormal Condition	Class 1, Division 2	Zone 2

In North America, explosion-proof ratings are classified into four groups, based on Material, Class, and Division. Division is based on frequency of occurrence.

**SIGHT GLASS LIGHTING
APPLICATIONS HANDBOOK**

Class I groups are based on explosive properties of the gas present. Another standards body is CENELEC, the European Committee for Electrotechnical Standardization. Cenelec uses three groups.

GAS	CLASS/DIVISION GAS GROUPS	ZONE GAS SYSTEM
Acetylene	A	II C
Hydrogen	B	
Ethylene	C	II B
Propane	D	II A

GAS	CLASS/DIVISION SYSTEM	ZONE SYSTEM
Gasses or Vapors	Class I, Division 1 Class I, Division 2	Zone 0 Zone 1 Zone 2
Combustible Dusts	Class II, Division 1 Class II, Division 2	Zone 20 Zone 21 Zone 22
Fibers or Flyings	Class III, Division 1 Class III, Division 2	No equivalent

Temperature Classes

Ignition temperature is the minimum temperature at which an explosive atmosphere ignites.

The maximum temperature of the sight glass light must be lower than the ignition temperature in order for it to meet a given explosion-proof rating. The following chart illustrates the maximum temperatures for each temperature class.

NORTH AMERICAN TEMPERATURE CODE	IEC/CENELEC/NEC 505 TEMPERATURE CLASSES	MAXIMUM TEMPERATURE	
		°C	°F
T1	T1	450°	842°
T2	T2	300°	572°
T2A	—	280°	536°
T2B	—	260°	500°
T2C	—	230°	446°
T2D	—	215°	419°
T3	T3	200°	392°
T3A	—	180°	356°
T3B	—	165°	329°
T3C	—	160°	320°
T4	T4	135°	275°
T4A	—	120°	248°
T5	T5	100°	212°
T6	T6	85°	185°

NEMA Requirements for Hazardous Locations

The National Electrical Manufacturers Association (NEMA) has a classification system for the enclosures of electrical devices, which indicate the level of protection the enclosure offers. This system follows the NEC hazard classifications.

- NEMA 7 enclosures are intended for indoor use in locations classified as Class I, Groups A, B, C or D as defined in the National Electrical Code (NEC).
- NEMA 8 enclosures are intended for indoor or outdoor use in locations classified as Class I, Groups A, B, C or D as defined in the National Electrical Code (NEC).
- NEMA 9 enclosures are intended for indoor use in locations classified as Class II, Groups A, B, C or D as defined in the National Electrical Code (NEC).
- NEMA 10 enclosures are intended for use in areas covered by the Mine Safety and Health Administration (MSHA).

NEMA and IP Ratings

Sight glass lights may need to be installed in areas subject to airborne dust or washdowns, and the light should be enclosed in a housing that will protect the light's internal components against dust and moisture. Specifiers can look to NEMA ratings or the IP rating defined in international standard IEC 60529.

NEMA RATING	DESCRIPTION	EQUIV. IP RATING
1	GENERAL PURPOSE. Intended for use indoors.	IP 10
2	GENERAL PURPOSE. Intended for use indoors with additional drip protection.	IP 10
3, 3S	GENERAL PURPOSE WEATHER-RESISTANT. Intended for use outdoors, with protection from windblown dust, rain and sleet, and undamaged by the formation of ice.	IP 10
3R	GENERAL PURPOSE WEATHER-RESISTANT. Intended for use outdoors, with protection from falling rain and sleet, and undamaged by the formation of ice.	IP 10
4, 4X	GENERAL PURPOSE WEATHER-PROOF. Intended for use indoors or outdoors, with protection from wash down environment and corrosion resistance.	IP 10
5	GENERAL PURPOSE DUST-TIGHT. Intended for use indoors or outdoors, with protection from dust provided by gaskets.	IP 10
6, 6P	GENERAL PURPOSE SUBMERSIBLE. Intended for use indoors or outdoors, with protection from occasional submersion.	IP 10
7	HAZARDOUS. Intended for indoor use in Class I, Groups A, B, C and D environments per NFPA rating system.	IP 10
8	HAZARDOUS. Intended for indoor or outdoor use in Class I, Groups A, B, C and D environments per NFPA rating system.	IP 10
9	HAZARDOUS. Intended for indoor or outdoor use in Class II, Groups E, F and G environments per NFPA rating system.	IP 10
12, 12K	INDUSTRIAL USE. Intended for use in industrial applications with protection from dust and non-corrosive liquid drip.	IP 10
13	INDUSTRIAL USE. Intended for use in industrial applications with protection from dust, spraying water, oil, and non-corrosive liquid drip.	IP 10

The IP rating classifies the degrees of protection provided against the intrusion of solid objects, dust, accidental contact, and water in electrical enclosures.

The chart on page 15 defines the NEMA ratings and shows their equivalent IP ratings.

Minimum Required Application Information

It is important to know the following information at a minimum to specify the appropriate light for a specific application. There may also be unusual factors or conditions to be taken into consideration such as extreme ambient temperatures, light or heat sensitive process media and equipment vibration to properly select a light. If there are remote switches/timers required or physical constraints, a diagram is very helpful. The more information, the better the selection.

Here is a checklist of the typical information needed in order to specify sight glass lighting:

Area Classification:

- Non-Explosion Proof
- Explosion-Proof (CENELEC)
- Explosion-Proof (UL)

Light Housing:

- Aluminum
- 316 Stainless Steel
- Special: _____

Mounting Configuration:

- Standard Bracket
- Sanitary Connection
- Special: _____

Available Power Supply:

- 120VAC
- 24VDC or AC
- 230VAC
- 12VDC or AC
- Other: _____

Desired Light Output:

- 5W
- 10W
- 20W
- 35W
- 50W
- 100W
- Other: _____

Vessel Dimensions:

- _____ diameter × _____ height
- Desired Vision Area in Vessel:
_____ diameter × _____ distance from light source

Light/Sight Port Information:

- Separate light and sight ports
- One port will be used for the light and sight

L.J. Star is a leading expert in the application of sight glasses and sight glass lighting. The broad product line includes

- **LED lights**
- **Halogen lights**
- **HID lights**
- **Fiber optic lights**
- **Explosion-proof lights**
- **Non-Ex lights**
- **Cordless lights**
- **Sanitary lights**



L.J. Star Incorporated

P.O. Box 1116

Twinsburg, OH 44087

Telephone: **(330) 405-3040**

FAX: **(330) 405-3070**

www.ljstar.com

For general information: **getmoreinfo@ljstar.com**

For pricing information: **priceinfo@ljstar.com**

For delivery information: **deliveryinfo@ljstar.com**

For technical information: **techinfo@ljstar.com**